

RiEx

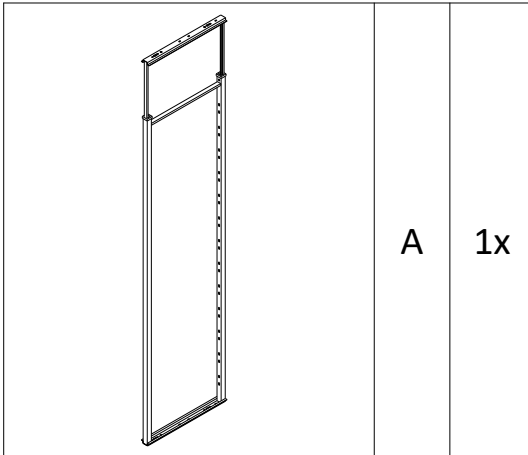

A 1x

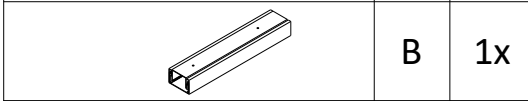

B 1x

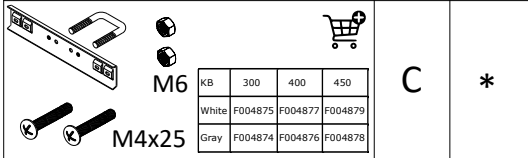

C *

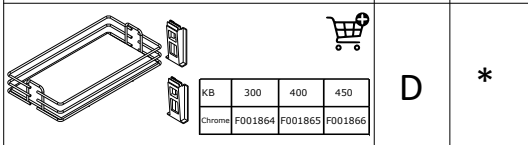

D *

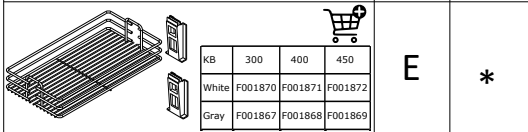

E *



F 12x

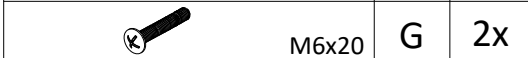

G 2x

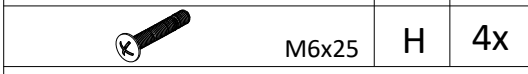

H 4x

H	*C	*D	*E
1250 - 1400	2	4	4
1400 - 1550	3	5	5
1550 - 1700	3	5	5
1700 - 1850	3	6	6
1850 - 2000	3	6	6
2000 - 2150	3	7	7

